

Bestellhinweis AL-KO Typenschilder



1. Achse

Daten vom Achstypenschild (in der Mitte der Achse aufgenietet / geklebt)

Einachs Tandem

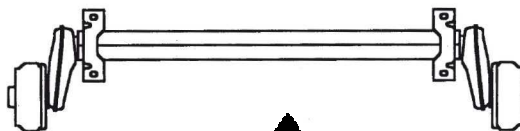
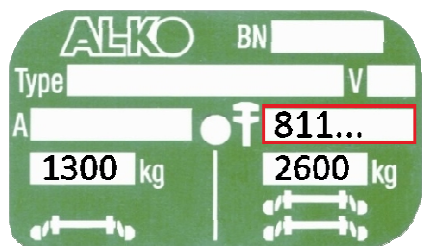

Ersatzachse

2. Radbremse

Typ der Radbremse (auf der Rückseite des Bremsankerblechs eingeprägt)

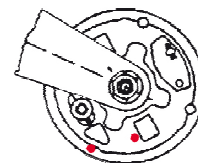

3. Auflaufeinrichtung

Typ und Ausführung der Auflaufeinrichtung (in Höhe des Handbremshebels eingeprägt)

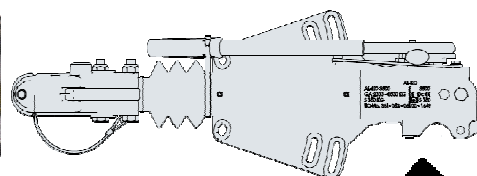
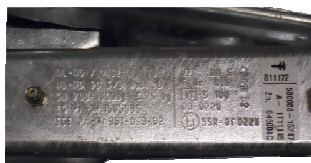
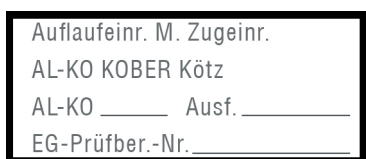

4. Zugverbindung

Typ und Gewichtsbereich der Holme (auf dem rechten Holm im vorderen Drittel eingepägt) an durchgehenden Rahmen ist keine Typeneinprägung Vorhanden!

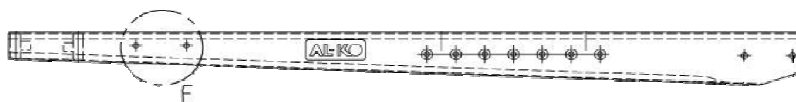

Bestellhinweis BPW Typenschilder



Ablezen der notwendigen Daten vom Typenschild

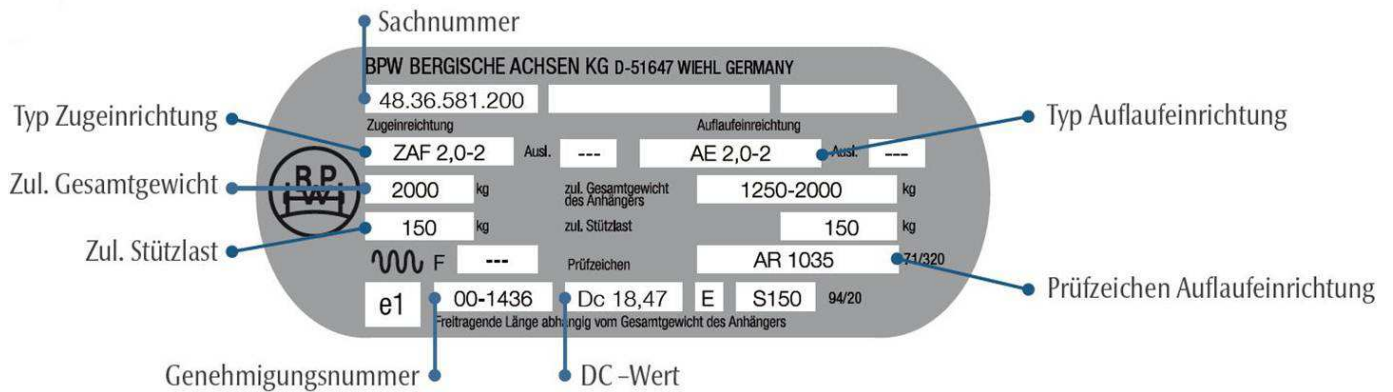

The diagram shows a BPW type plate with the following data points and callouts:

- Sachnummer:** 48.36.581.200
- Typ Zugeinrichtung:** ZAF 2,0-2
- Typ Auflaufeinrichtung:** AE 2,0-2
- Zul. Gesamtgewicht:** 2000 kg
- Zul. Stützlast:** 150 kg
- Prüfzeichen Auflaufeinrichtung:** AR 1035
- Genehmigungsnummer:** e1
- DC-Wert:** Dc 18,47

Additional information on the plate includes: BPW BERGISCHE ACHSEN KG D-51647 WIEHL GERMANY, Zul. Gesamtgewicht des Anhängers: 1250-2000 kg, zul. Stützlast: 150 kg, Prüfzeichen: AR 1035, and Freitragende Länge abhängig vom Gesamtgewicht des Anhängers.

Ablezen der notwendigen Daten vom Typenschild

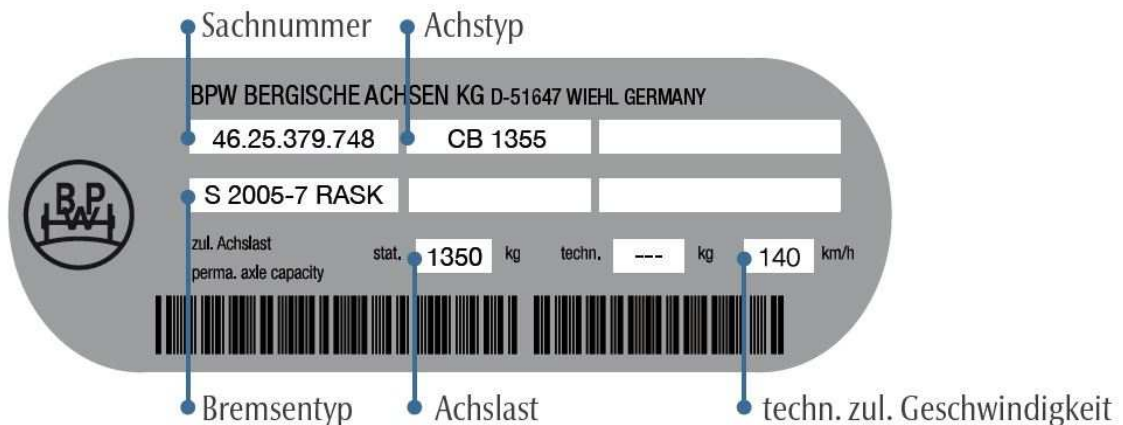

The diagram shows a BPW type plate with the following data points and callouts:

- Sachnummer:** 46.25.379.748
- Achstyp:** CB 1355
- Bremsentyp:** S 2005-7 RASK
- Achslast:** 1350 kg
- techn. zul. Geschwindigkeit:** 140 km/h

Additional information on the plate includes: BPW BERGISCHE ACHSEN KG D-51647 WIEHL GERMANY, zul. Achslast perma. axle capacity: 1350 kg, and techn. --- kg.

Bestellhinweis Knott Typenschilder

Typisierung KNOTT Komponenten



ALLE Angaben auf Typenschild
oder wahlweise auf Bauteil
eingenadelt oder eingeprägt

**Auflaufeinrichtung
mit Zugeinrichtung**

KNOTT GmbH		D-8155 Nassenwil	
Auflaufeinrichtung Typ:	KF27	Ausf.:	B
EG-Profil-Nr.:	361-041-82		
EZF-Profil-Nr.:	11/0046-00		
mit Zugeinrichtung Typ:	KF27Z	Ausf.:	A1 / -
zul. Gesamtlast:	1450 kg	2700 kg	
zul. Nutzlast:	150 kg	Do/Dc:	25.0 mm
Gewichtspunkt:	00-0757	Klasse:	E



Zugholm
(rechter Zugholm)

KNOTT GmbH		D-8155 Nassenwil	
Zugkugel Typ:	ZH27	Ausf.:	E
zul. Gesamtlast:	3000		
Gewichtspunkt:	e1 00-0300	E1 55R-010300	
zul. Nutzlast:	150 kg	Do/Dc:	30.0 mm / 31 mm

Zugkugelkupplung
(Angaben auf Griff oder Gehäuse)

KNOTT GmbH		D-8155 Nassenwil	
Typ:	K27	Ausf.:	A
e1 00-0507	B50X		
Do/Dc:	25 kN	S:	150 kg



Zugöse

KNOTT GmbH		D-8155 Nassenwil	
Typ:	26-0086-09		
e1 00-0680	S	E1 55R-012026	
Do:	30,95 kN	S:	150 kg
Do/Dc:	31 kN	S:	350 kg

Radbremse

KNOTT GmbH		D-8155 Nassenwil	
Typ:	20-2425/1		
EG-Profil-Nr.:	361-311-83		
Gürtel-Nr. / Mch:	83/224		
bis 25 km/h:	1360 kg		
über 25 km/h:	750 kg / 800 kg		



Achse

KNOTT GmbH		D-8155 Nassenwil	
Typ:	V5813M-27222		
AB-Nr.:			
Achslast:	1350 kg	über 25 km/h:	

Bremsbackensätze

AL-KO



Bremsbackensätze pro Achse inkl. Federn!

Bestell-Nr.	Bremsentyp	Größe	Hersteller
251635	1635 / 1636 / 1637	160x35	AL-KO
1220327	1640	160x40	AL-KO

Bestell-Nr.	Bremsentyp	Größe	Hersteller
252035	2035	200x35	AL-KO
252050	2050 / 2051	200x50	AL-KO

Bestell-Nr.	Bremsentyp	Größe	Hersteller
252052	2051 AAA	200x50	AL-KO

Automatische Nachstellung

**Bremsbacken nur im Ersatz zu Kit 252055 /
Umrüstung 2051 auf 2051 AAA siehe Seite 8.14**

Bestell-Nr.	Bremsentyp	Größe	Hersteller
252350	2350	230x50	AL-KO

Bestell-Nr.	Bremsentyp	Größe	Hersteller
252360	2360 / 2361	230x60	AL-KO
252362 (ohne Abb.)	2361 AAA (im Ersatz zu 252366)	230x60	AL-KO

Bestell-Nr.	Bremsentyp	Größe	Hersteller
253060	3060 / 3061	300x60	AL-KO

Bremsbackensätze

Bremsbackensätze pro Achse inkl. Federn!

AL-KO



Bestell-Nr.	Bremsentyp	Größe	Hersteller
253062	3062	300x60	AL-KO



Bestell-Nr.	Bremsentyp	Größe	Hersteller
252080	3080	300x80	AL-KO



Bestell-Nr.	Bremsentyp	Größe	Hersteller
253081	3081	300x80	AL-KO



Bestell-Nr.	Bremsentyp	Größe	Hersteller
251636	SB 160	160x35	AL-KO
252042	SB 200	200x35	AL-KO
N.m.l.	SB 200	200x30	AL-KO
252341	SB 230	230x40	AL-KO
N.m.l.	SB 250		AL-KO
252301	SB 301	300x60	AL-KO



Bestell-Nr.	Bremsentyp	Größe	Hersteller
N.m.l.	SR 160		AL-KO
252031	SR 201/ SR202 SR 203	200x35	AL-KO
252332	SR 230/ SR 230S	230x40	AL-KO

Bremsbackensätze

Bremsbackensätze pro Achse inkl. Federn!

BPW



Bestell-Nr.	Bremsentyp	Größe	Hersteller
801451	S 2304 SK	230x40	BPW
801453	S 2304-2 RASK	230x40	BPW



Bestell-Nr.	Bremsentyp	Größe	Hersteller
801455	S 2504 SK	250x40	BPW



Bestell-Nr.	Bremsentyp	Größe	Hersteller
621635	S 1635-6 RASK	160x35	BPW

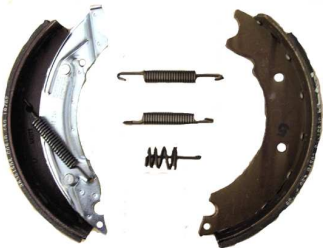

Bestell-Nr.	Bremsentyp	Größe	Hersteller
612030	S 2003-5 RASK	200x30	BPW
620082	S 2005-5 RASK	200x50	BPW



Bestell-Nr.	Bremsentyp	Größe	Hersteller
625040	S 2504-5 RASK	250x40	BPW



Bestell-Nr.	Bremsentyp	Größe	Hersteller
623060	S 3006-5 RASK	300x60	BPW

Bremsbackensätze

Bremsbackensätze pro Achse inkl. Federn!

BPW



Bestell-Nr.	Bremsentyp	Größe	Hersteller
842170	S 1704-7 RASK	170x40	BPW



Bestell-Nr.	Bremsentyp	Größe	Hersteller
842035	S 2035-7 RASK	200x35	BPW



Bestell-Nr.	Bremsentyp	Größe	Hersteller
842050	S 2005-7 RASK	200x50	BPW
842340	S 2304-7 RASK	230x40	BPW



Bestell-Nr.	Bremsentyp	Größe	Hersteller
882050	S 2005-8 RANSK	200x50	BPW

**Bremsbacken passend zu Bremse S 2005-8 RANSK
(automatische Nachstellung) - Nur im Ersatz auszutauschen**



Bestell-Nr.	Bremsentyp	Größe	Hersteller
842540	S 2504-7 RASK	250x40	BPW
843060	S 3006-7 RASK	300x60	BPW

Bremsbackensätze

DDR-Bremsbacken



Bestell-Nr.	Anhängertyp	Größe	Hersteller
740033 (ohne Federn)	HP500/600 (Spreizhebel)	200x30	DDR



Bestell-Nr.	Anhängertyp	Größe	Hersteller
740035 (ohne Federn)	HP800 (hydr.)	230x50	DDR

Bremsbackensätze

Hahn

Bremsbackensätze pro Achse inkl. Federn!



Bestell-Nr.	Bremsentyp	Größe	Hersteller
118841	B 200/1	200X30	Hahn
111625	B 201/1 und B 201/2	200X35	Hahn
111514	B/BA 230/1-5	230x40	Hahn
111516	B 250/1-5	250x40	Hahn



Bestell-Nr.	Bremsentyp	Größe	Hersteller
118840	BA 201/1	200x35	Hahn
118842	BA 202/1	200x30	Hahn



Bestell-Nr.	Bremsentyp	Größe	Hersteller
111626	BAN 201/1	200x35	Hahn
111515	BAN 230/1	230x40	Hahn
111517	BAN 250/1	250x40	Hahn



Bestell-Nr.	Bremsentyp	Größe	Hersteller
111015	CC 6200	200X35	Hahn
111016	CC 6230	230X40	Hahn
111017	CC 6250	250x40	Hahn



Bestell-Nr.	Bremsentyp	Größe	Hersteller
111018	CC 6300	300X60	Hahn

Bremsbackensätze

Bremsbackensätze pro Achse inkl. Federn!

Knott

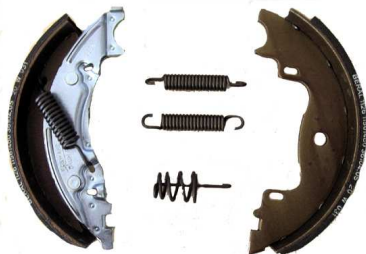

Bestell-Nr.	Bremsentyp	Größe	Hersteller
621635	16-1365 Spreizhebel	160x35	Knott



Bestell-Nr.	Bremsentyp	Größe	Hersteller
620082	20-964/1 und 20-2425/1 Spreizhebel	200x50	Knott
620080	20-966/1 ohne Rückmatik	200x50	Knott
612020	20-965/1 ohne Rückmatik	200x30	Knott
612030	20-963/1 mit Rückmatik	200x30	Knott

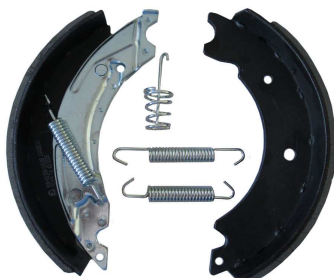

Bestell-Nr.	Bremsentyp	Größe	Passend für
622020	20,32-1647 Spreizhebel (Avonride)	203,2x4 0 (Zoll)	Knott

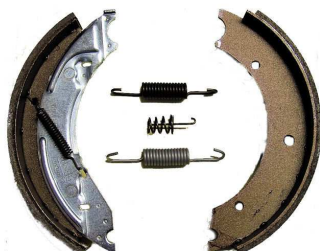

Bestell-Nr.	Bremsentyp	Größe	Hersteller
625040	25-2025 Spreizhebel	250x40	Knott
625042	25-2026 ohne Rückmatik	250x40	Knott



Bestell-Nr.	Bremsentyp	Größe	Hersteller
623060	30-2261 Spreizhebel	300x60	Knott
623061	30-2355 ohne Rückmatik	300x60	Knott

Bremsbackensätze

Bremsbackensätze pro Achse inkl. Federn!

Knott



Bestell-Nr.	Bremsentyp	Größe	Hersteller
622250	20-2710 Hydraulik	200x50 Hyd.	Knott



Bestell-Nr.	Bremsentyp	Größe	Hersteller
622254	25-4066 Hydraulik	250x40 Hyd.	Knott



Bestell-Nr.	Bremsentyp	Größe	Hersteller
622544	25-4303 Hydraulik	250x40 Hyd.	Knott



Bestell-Nr.	Bremsentyp	Größe	Hersteller
623062	30-4302 Hydraulik	300x60 Hyd.	Knott

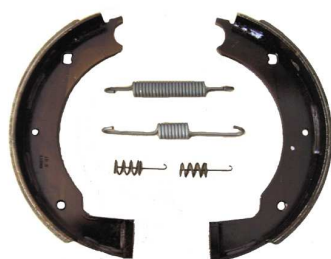

Bestell-Nr.	Bremsentyp	Größe	Hersteller
623065	30-3129 Nocken	300x60 Nocken	Knott

Bremsbackensätze

Bremsbackensätze pro Achse inkl. Federn!

Knott



Bestell-Nr.	Bremsentyp	Größe	Hersteller
620055	20-2425/1 Spreizhebel	200x50 automat.	Knott

Automatische Nachstellung

Ab Baujahr 2013



Bestell-Nr.	Bremsentyp	Größe	Hersteller
625045	25-2025 Spreizhebel	250x40 automat.	Knott

Automatische Nachstellung

Bremsbackensätze

Nieper

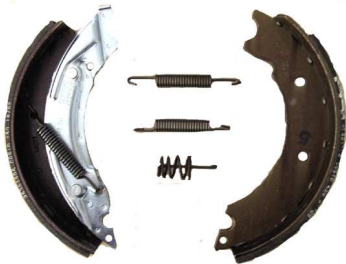

Bremsbackensätze pro Achse inkl. Federn!

Bestell-Nr.	Bremsentyp	Größe	Hersteller
780080	GU 230x30	230x30	Nieper
780082	GU 250x40	250x40	Nieper

Bestell-Nr.	Bremsentyp	Größe	Hersteller
780081	GU 230x30 RA	230x30	Nieper
780083	GU 250x40 RA	250x40	Nieper

Bestell-Nr.	Bremsentyp	Größe	Hersteller
620082	20-964/1 20-2425/1	200x50	Nieper mit Knott Bremse
625040	25-2025	250x40	Nieper mit Knott Bremse

Bestell-Nr.	Bremsentyp	Größe	Hersteller
623060	30-2261	300x60	Nieper mit Knott Bremse

Bremsbackensätze

Bremsbackensätze pro Achse inkl. Federn!

Peitz



Bestell-Nr.	Bremsentyp	Größe	Hersteller
421635	R 160-76	160X35	Peitz



Bestell-Nr.	Bremsentyp	Größe	Hersteller
418011	R 164-83	160X40	Peitz



Bestell-Nr.	Bremsentyp	Größe	Hersteller
418012	R 205-83	200X50	Peitz

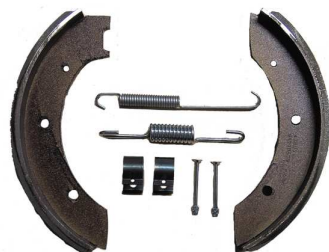

Bestell-Nr.	Bremsentyp	Größe	Hersteller
418013	S 234 R	230x40	Peitz



Bestell-Nr.	Bremsentyp	Größe	Hersteller
423040	R 234-76	230x40	Peitz

Bremsbackensätze

Schlegl

Bremsbackensätze pro Achse inkl. Federn!



Bestell-Nr.	Bremsentyp	Größe	Hersteller
752036	SGB 9 - SGB 15	200x50	Schlegl



Bestell-Nr.	Bremsentyp	Größe	Hersteller
620082	SKB 9 - SKB 15	200x50	Schlegl mit Knott Bremse
625040	SKB 18	250x40	Schlegl mit Knott Bremse

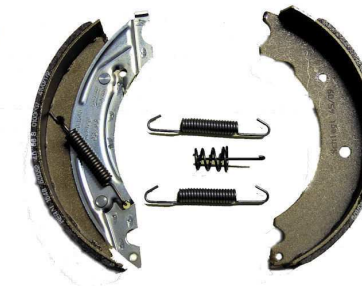

Bestell-Nr.	Bremsentyp	Größe	Hersteller
752250	520	200x50	Schlegl

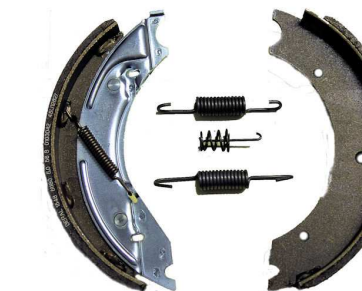

Bestell-Nr.	Bremsentyp	Größe	Hersteller
752540	425	250x40	Schlegl



Bestell-Nr.	Bremsentyp	Größe	Hersteller
752300	730	300x70	Schlegl

Bremsbackensätze

Bremsbackensätze pro Achse inkl. Federn!

WAP



Bestell-Nr.	Bremsentyp	Größe	Hersteller
300026	W184-RS	180x40	WAP



Bestell-Nr.	Bremsentyp	Größe	Hersteller
300027	W205 RS Humbaur	200x50	WAP

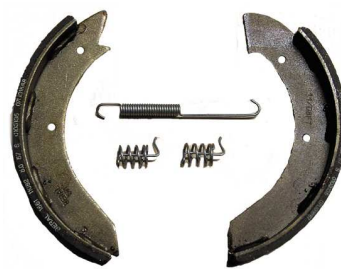

Bestell-Nr.	Bremsentyp	Größe	Hersteller
423040	W234-RS	230x40	WAP

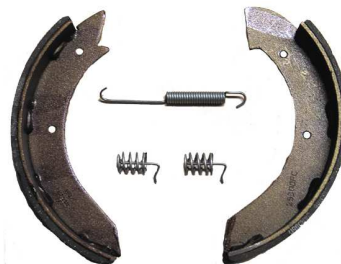

Bestell-Nr.	Bremsentyp	Größe	Hersteller
300029	W235-RS	230X50	WAP

Faltenbälge für Auflaufeinrichtungen



Bestell-Nr.	Bezeichnung
2073890210	AL-KO Faltenbalg 30/40 L=120 mm



Bestell-Nr.	Bezeichnung
366356	AL-KO Faltenbalg 50/55 L=130 mm mit Schraubenabdeckung horizontal



Bestell-Nr.	Bezeichnung
353937	AL-KO Faltenbalg 49/50 L=130 mm mit Schraubenabdeckung horizontal



Bestell-Nr.	Bezeichnung
21726605	AL-KO Faltenbalg 55/70 L=125 mm



Bestell-Nr.	Bezeichnung
564019	AL-KO Faltenbalg 35/45 L=110 mm



Bestell-Nr.	Bezeichnung
607133	AL-KO Faltenbalg 37/54 L=115 mm Safety Compact AKS3004, 351ZA



Bestell-Nr.	Bezeichnung
671011	Bradley Faltenbalg 75/80 L=150 mm mit Schraubenabdeckung horizontal Passend für H35 & EH35



Bestell-Nr.	Bezeichnung
671010	Bradley Faltenbalg 45/60 L=120 mm passend für Typ H09-H26 & EH09-EH27

Faltenbälge für Auflaufeinrichtungen



Bestell-Nr.	Bezeichnung
843005	BPW Faltenbalg ZAF bis 2.0 50/60 L=145 mm Schraubenabdeckung



Bestell-Nr.	Bezeichnung
843120	BPW Faltenbalg ZAF bis 2,8-2 55/60 L= 150 mm Schraubenabdeckung



Bestell-Nr.	Bezeichnung
843017	BPW Faltenbalg ZAF 2,8 60/65 L=155 mm



Bestell-Nr.	Bezeichnung
800218	BPW Faltenbalg ZAF 3,5 65/85 L=130 mm



Bestell-Nr.	Bezeichnung
800263	BPW Faltenbalg AK 3509 55/60 L=155 mm



Bestell-Nr.	Bezeichnung
843217	BPW Faltenbalg ZAAQ VKT 70 52/82 L=150 mm



Bestell-Nr.	Bezeichnung
800080	BPW/Grüner 45/60 L=110 mm



Bestell-Nr.	Bezeichnung
800081	BPW/Grüner 90/110 L=110 mm



Bestell-Nr.	Bezeichnung
800069	BPW/Grau/Grüner 55/60 L=130 mm

Faltenbälge für Auflaufeinrichtungen



Bestell-Nr.	Bezeichnung
671010	Bradley Faltenbalg 45/60 L=120 mm



Bestell-Nr.	Bezeichnung
015780	Hahn Faltenbalg 37/46 L=125 mm



Bestell-Nr.	Bezeichnung
167470	Hahn Faltenbalg 50/70 L=120 mm



Bestell-Nr.	Bezeichnung
015800	Hahn Faltenbalg 55/75 L=180 mm



Bestell-Nr.	Bezeichnung
600155	Knott Faltenbalg 55/60 L=130 mm m. Schraubenabdeckung



Bestell-Nr.	Bezeichnung
610055	Knott Faltenbalg 70/75 L=150 mm



Bestell-Nr.	Bezeichnung
600055	Knott Faltenbalg 55/60 L=110 mm



Bestell-Nr.	Bezeichnung
610560	Knott Faltenbalg 62/72 L=160 mm IFOR-Williams Ausf.

Faltenbälge für Auflaufeinrichtungen



Bestell-Nr.	Bezeichnung
408018	Peitz Faltenbalg 60/80 L=105 mm PAH
408016	Peitz Faltenbalg 60/60 L=105 mm PAV



Bestell-Nr.	Bezeichnung
407136	Peitz/BPW 57/70 L=170 mm PAV-X



Bestell-Nr.	Bezeichnung
751402	Schlegl Faltenbalg 55/60 L=145 mm



Bestell-Nr.	Bezeichnung
752044	Schlegl Faltenbalg 70/70 L=120 mm



Bestell-Nr.	Bezeichnung
310030	WAP Faltenbalg 57/64 L=110 mm
310031	WAP Faltenbalg 55/70 L=115 mm



Bestell-Nr.	Bezeichnung
310033	WAP Faltenbalg 40/72 L=145 mm



Bestell-Nr.	Bezeichnung
760105	Westfalia Faltenbalg 35/60 L=110 mm



Bestell-Nr.	Bezeichnung
760003	Westfalia Faltenbalg 35/55 L=80 mm



Bestell-Nr.	Bezeichnung
760149	Westfalia Faltenbalg 75/75 geteilt

Bremssseile AL-KO Profi Longlife

AL-KO Bremsseile mit Langloch-Öse

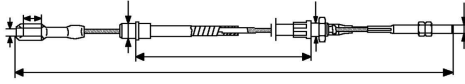

Bestell-Nr.	Ges.Länge B	Hüllenlänge A	Anschluss a	Anschluss b	Hüllen- ende
2088800405	605	349	M8	Öse 15x7	M12x1,5
2088800404	785	529	M8		
2088800403	1025	769	M8		
20888004	1145	889	M8		
2088800406	1265	1009	M8		
2088800401	1385	1129	M8		
2088800402	1565	1309	M8		
21841804	1685	1429	M8		
24866304	1865	1609	M8		
24866305	2045	1789	M8		

AL-KO Bremsseile mit Nippel ohne Glocke

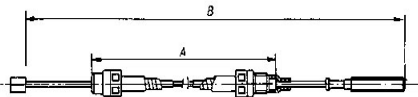

Bestell-Nr.	Ges.Länge B	Hüllenlänge A	Anschluss a	Anschluss b	Hüllen- ende
27819604	820	560	M10	Nippel	M14x1,5
2781960401	1060	800	M10		
2781960402	1180	920	M10		
2781960403	1300	1040	M10		
2781960404	1420	1160	M10		
2781960405	1600	1340	M10		



Bestell-Nr.	Bezeichnung
2781960014	Einhängeöse

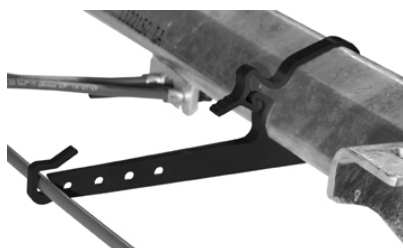

Achsform



Bestell-Nr.	Bezeichnung	Achstyp AL-KO ab Baujahr
1222113	Halter Bremsseile Achskörper 97 mm	Compact ab 95 Plus ab 99
1222114	Halter Bremsseile Achskörper 80 mm	Compact ab 95 Plus ab 99
1222115	Halter Bremsseile Achskörper 110 mm	Compact ab 95 Plus ab 99

Bestell-Nr.	Bezeichnung	Achstyp andere Hersteller
1222116	Halter Bremsseile	Achskörper Vierkant 80

Bremsseile AL-KO Profi-Longlife

AL-KO Bremsseile mit Glocke außen 26 mm

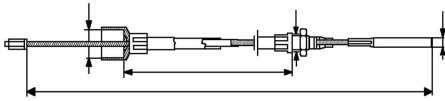

Bestell-Nr.	Bezeichnung
604262	Einhängeöse

Bestell-Nr.	Ges.Läng e S	Hüllenlänge H	Anschluss a	Anschluss b	Hüllenende
299707	560	350	M8	Nippel	M12x1,5
299708	740	530	M8		
299709	980	770	M8		
299710	1100	890	M8		
299711	1230	1020	M8		
299712	1340	1130	M8		
299713	1530	1320	M8		
299714	1640	1430	M8		
299715	1830	1620	M8		
299716	2000	1790	M8		

AL-KO Bremsseile mit Glocke außen 26 mm Schnellmontage

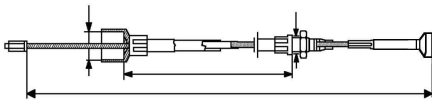

Bestell-Nr.	Bezeichnung
604262	Einhängeöse

Bestell-Nr.	Ges.Länge S	Hüllenlänge H	Anschluss b	Hüllenende
247281	546	350	Nippel	M12x1,5
247282	726	530		
1213129	836	640		
247283	966	770		
247284	1086	890		
247285	1216	1020		
247286	1326	1130		
247287	1516	1320		
247288	1626	1430		
247289	1816	1620		
247290	1986	1790		

AL-KO Bremsseile mit Glocke außen 30 mm

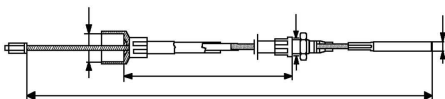

Bestell-Nr.	Bezeichnung
372891	Einhängeöse

Bestell-Nr.	Ges.Länge S	Hüllenlänge H	Anschluss a	Anschluss b	Hüllenende
241106	760	500	M10	Nippel	M16x1,5
241107	1060	800	M10		
241108	1160	900	M10		
241109	1260	1000	M10		
241110	1360	1100	M10		
241111	1560	1300	M10		
241112	1660	1400	M10		
241113	1860	1600	M10		

Bremssseile BPW

Bremssseile BPW alte Ausführung Langloch-Öse

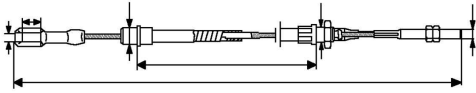

Bestell-Nr.	Ges. Länge B	Hüllenlänge A	Anschluss a	Anschluss b	Hüllenende
800830	1030	830	M8	Öse 15x7	M10x1/14x5
800930	1130	930	M8		
801030	1230	1030	M8		
801130	1330	1130	M8		
801230	1430	1230	M8		
801330	1530	1330	M8		
801430	1630	1430	M8		

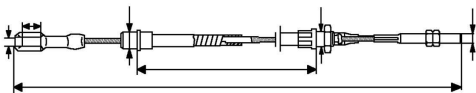

Bestell-Nr.	Ges. Länge B	Hüllenlänge A	Anschluss a	Anschluss b	Hüllenende
820830	1040	830	M8	Öse 15x7	M10x1/14x10
810830	1070	830	M8		
820930	1140	930	M8		
810930	1150	930	M8		
821030	1240	1030	M8		
811030	1250	1030	M8		
821130	1340	1130	M8		
811130	1350	1130	M8		
821230	1440	1230	M8		
811230	1450	1230	M8		
811430	1670	1430	M8		

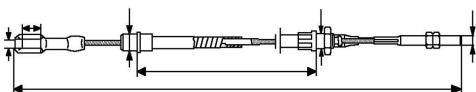

Bestell-Nr.	Ges. Länge B	Hüllenlänge A	Anschluss a	Anschluss b	Hüllenende
830630	900	630	M8	Öse 18x7	M12x1,5/14
830730	1000	730	M8		
830830	1100	830	M8		
830930	1200	930	M8		
831030	1300	1030	M8		
831130	1400	1130	M8		
831230	1500	1230	M8		
831330	1600	1330	M8		

Bremssseile BPW

Bremssseile BPW mit Glocke außen 22 mm

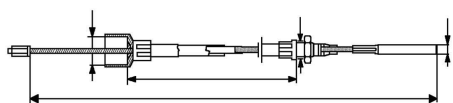

Bestell-Nr.	Bezeichnung
600064	Einhängeöse

Bestell-Nr.	Ges.Länge S	Hüllnlänge H	Anschluss a	Anschluss b	Hüllende
610400	640	430	M8	Nippel	M12x1,5
610500	740	530	M8		
610600	840	630	M8		
610700	940	730	M8		
610800	1040	830	M8		
610930	1140	930	M8		
611000	1240	1030	M8		
611130	1340	1130	M8		
611200	1440	1230	M8		
611350	1540	1330	M8		
611400	1640	1430	M8		
611530	1740	1530	M8		
611600	1840	1630	M8		
611990	2240	2030	M8		
611730	1940	1730	M8		
611800	2040	1830	M8		

Bremssseile BPW mit Glocke außen 26 mm

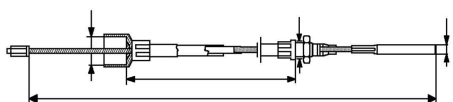

Bestell-Nr.	Bezeichnung
840026	Einhängeöse

Bestell-Nr.	Ges.Länge S	Hüllnlänge H	Anschluss a	Anschluss b	Hüllende
840430	655	430	M8	Nippel	M12x1,5
840531	755	530	M8		
840630	855	630	M8		
840730	955	730	M8		
840830	1055	830	M8		
840930	1155	930	M8		
841030	1255	1030	M8		
841130	1355	1130	M8		
841230	1455	1230	M8		
841330	1555	1330	M8		
841430	1655	1430	M8		
841530	1755	1530	M8		
841630	1855	1630	M8		
841730	1955	1730	M8		
841930	2175	1930	M8		

Bremssseile Hahn

Bremssseile Hahn mit Langlochöse 10x7,5 (Hüllenfassung M14 gesteckt)

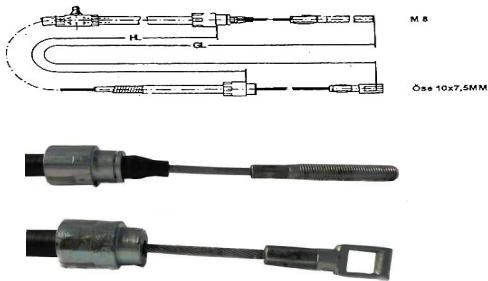

Bestell-Nr.	Ges.Länge	Hüllenfänge	Anschluss a	Anschluss b	Bremse
035460	635	400	M8	Öse 10x7,5	Bis 250x40
035470	735	500	M8		
035480	835	600	M8		
035490	935	700	M8		
035510	1035	800	M8		
035530	1135	900	M8		
035550	1235	1000	M8		
035570	1335	1100	M8		
035580	1435	1200	M8		
035590	1535	1300	M8		
035600	1635	1400	M8		
095070	1735	1500	M8		
095080	1835	1600	M8		
185580	2235	2000	M8		

Bremssseile Hahn mit Langlochöse 18x9 (Hüllenfassung M18 gesteckt)

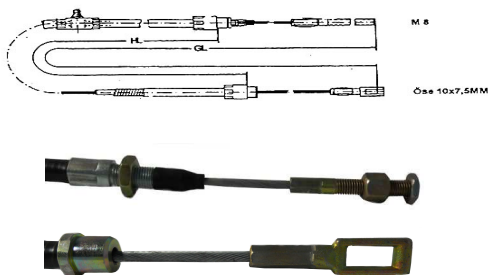

Bestell-Nr.	Ges.Länge	Hüllenfänge	Anschluss a	Anschluss b	Für Bremse
035650	710	400	M10	Öse 18x9	Ab 300x60
107510	810	500	M10		
035680	910	600	M10		
099830	1010	700	M10		
035710	1110	800	M10		
035730	1210	900	M10		
035750	1310	1000	M10		
035770	1410	1100	M10		
035790	1510	1200	M10		
035800	1610	1300	M10		
081350	1710	1400	M10		
147070	1810	1500	M10		
140830	2110	1800	M10		
185570	2135	1900	M10		

Bremssseile Hahn BAN und CC Bremse

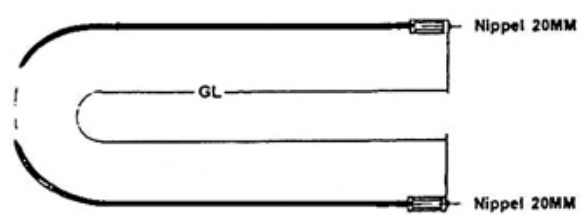
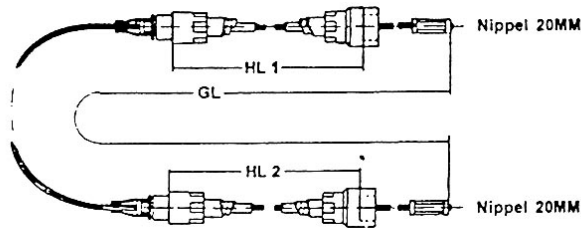

Bestell-Nr.	Ges.Länge	Hüllenslänge 1	Hüllenslänge 2
154850	1020	280	280
165010	1120	330	330
165020	1220	380	380
165030	1320	430	430
261740 (Putz)	1720	430	830
262760	1650	460	700
165040	1420	480	480
262762	1660	480	720
262770	1750	510	750
262780	1850	530	800
165050	1520	530	530
165070	1720	630	630
165080	1820	680	680
165090	1920	730	730
165100	2020	780	780
165110	2120	830	830
165120	2220	880	880
165130	2320	930	930
165140	2420	980	890
165150	2520	1030	1030
165160	2620	1080	1080
253260 Karo	2820	1080	1380
165170	2720	1130	1130
165180	2820	1180	1180
165190	2920	1230	1230
165200	3020	1280	1280
194670	3420	1480	1480
194600	4300	1930	1480

Bestell-Nr.	Seile ohne Hülle
164430	GL=1300 mm
164450	GL= 1500 mm
164460	GL= 1600 mm
164470	GL= 1700 mm
164480	GL= 1800 mm
164490	GL= 1900 mm
164500	GL= 2000 mm
164510	GL= 2100 mm
164520	GL= 2200 mm
164530	GL= 2300 mm
164540	GL= 2400 mm
164550	GL= 2500 mm
164560	GL= 2600 mm
164570	GL= 2700 mm

Bestell-Nr.	Ausgleichseil beidseitig M10 Gewinde ohne Abbildung
160660	Seillänge 1080 mm
164910	Seillänge 1180 mm
164920	Seillänge 1280 mm
164930	Seillänge 1380 mm
164940	Seillänge 1480 mm



Bestell-Nr.	Bezeichnung
750650	SL-KL Sicherung für M14 Hahn

Bremseile Knott

Bremseile Knott/Peitz mit Glocke außen 22 mm

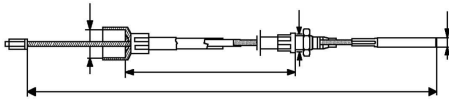

Bestell-Nr.	Bezeichnung
600064	Einhängeöse

Bestell-Nr.	Ges.Länge S	Hüllenlänge H	Anschluss a	Anschluss b	Hülenenende
610400	640	430	M8	Nippel	M12x1,5
610500	740	530	M8		
610600	840	630	M8		
610700	940	730	M8		
610800	1040	830	M8		
610930	1140	930	M8		
611002	1240	1000	M8		
611000	1240	1030	M8		
611130	1340	1130	M8		
611202	1440	1200	M8		
611200	1440	1230	M8		
611350	1540	1330	M8		
611400	1640	1430	M8		
611530	1740	1530	M8		
611600	1840	1630	M8		

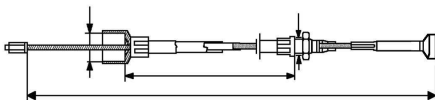

Bestell-Nr.	Bezeichnung
600064	Einhängeöse

Bremseile Knott mit Glocke außen 22 mm Schnellmontage

Bestell-Nr.	Ges.Länge S	Hüllenlänge H	Anschluss b	Hülenenende
650530	720	530	Nippel	M12x1,5
650630	820	630		
650730	920	730		
650830	1020	830		
650930	1120	930		
651030	1220	1030		
651130	1340	1130		
651230	1420	1230		
651330	1520	1330		
651430	1620	1430		
651530	1720	1530		
651630	1820	1630		

Bremseile Knott

Bremseile Knott mit Glocke außen 22 mm NIROSTA

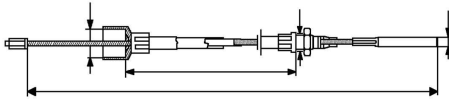

Bestell-Nr.	Bezeichnung
600064	Einhängeöse

Bestell-Nr.	Ges.Länge S	Hüllenlänge H	Anschluss a	Anschluss b	Hüllende
610705	940	730	M8	Nippel	M12x1,5
610805	1040	830	M8		
610905	1140	930	M8		
611005	1240	1030	M8		
611105	1340	1130	M8		
611205	1440	1230	M8		
611355	1540	1330	M8		
611405	1640	1430	M8		
611505	1740	1530	M8		
611605	1840	1630	M8		

Bremseile Knott mit Glocke außen 30 mm

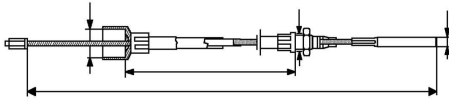

Bestell-Nr.	Bezeichnung
600364	Einhängeöse

Bestell-Nr.	Ges.Länge S	Hüllenlänge H	Anschluss a	Anschluss b	Hüllende
640500	760	500	M10	Nippel	M16x1,5
640600	860	600	M10		
640700	960	700	M10		
640800	1060	800	M10		
640900	1160	900	M10		
640955	1215	955	M10		
641000	1260	1000	M10		
641100	1360	1100	M10		
641200	1460	1200	M10		
641300	1560	1300	M10		
641400	1660	1400	M10		
641600	1860	1600	M10		
642000	2260	2000	M10		

Bremseile Knott

Bremseile Knott Hydraulik



Bestell-Nr.	Ges.Länge S	Hüllenlänge H	Anschluss a	Anschluss b	Hüllenende
641150	1310	1150	M8	Nippel	M12x1,5
641350	1510	1350			
641650	1810	1650			
641850	2010	1850			
642050	2210	2050			
642250	2410	2250			

Seilzugadapter Knott



Bestell-Nr.	Bremstyp	Ausführung
620216	200 x 50 Hydraulik	gerade
620092		gekröpft 30°
620203	250 x 40 Hydraulik	gerade
620078		gekröpft 30°
630315	300 x 60 Hydraulik	gekröpft 30°

Bremsseile Knott / Peitz

Bremsseile Knott mit Langloch-Öse

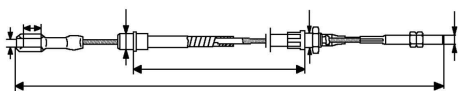

Bestell-Nr.	Ges.Länge B	Hüllenlänge A	Anschluss a	Anschluss b	Hülenenende
600700	1000	700	M8	Öse 18x7,5	M12x1,5
600800	1100	800	M8		
600900	1200	900	M8		
601000	1300	1000	M8		
601100	1400	1100	M8		
601200	1500	1200	M8		
601350	1650	1350	M8		
601400	1700	1400	M8		
601500	1800	1500	M8		
601600	1900	1600	M8		

Bremsseile Knott mit Langloch-Öse

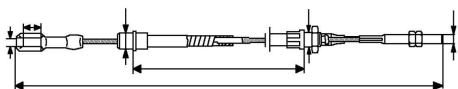

Bestell-Nr.	Ges..Länge B	Hüllenlänge A	Anschluss a	Anschluss b	Hülenenende
630700	1000	700	M10	Öse 18x7,5	M16x1,5
630800	1100	800	M10		
630900	1210	900	M10		
631000	1300	1000	M10		
631200	1500	1200	M10		
631400	1700	1400	M10		

Bremsseile Peitz Langloch-Öse

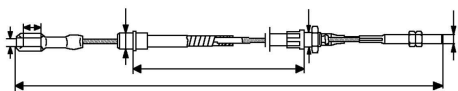

Bestell-Nr.	Ges.Länge B	Hüllenlänge A	Anschluss a	Anschluss b	Hülenenende
400700	975	700	M8	Öse 15x7	M12x1,5
400800	1075	800	M8		
400900	1175	900	M8		
401000	1275	1000	M8		
401100	1375	1100	M8		
401150	1450	1150	M8		
401175	1450	1175	M8		
401300	1575	1300	M8		
401450	1800	1450	M8		
401525	1800	1525	M8		
401850	2125	1850	M8		

Bremssseile WAP / Humbaur WAP

Bremssseile WAP mit Glocke 22 mm außen mit Schrauböse

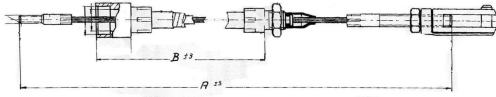

Bestell-Nr.	Bezeichnung
300032	Schrauböse

Bestell-Nr.	Ges.Länge A mm	Hüllenlänge B	Anschluss a	Anschluss b	Hüllende
310110	730	500	M8	M6	M12x1,5
311111	830	600	M8		
310101	930	700	M8		
310102	1030	800	M8		
310103	1130	900	M8		
310104	1230	1000	M8		
310105	1330	1100	M8		
310106	1405	1175	M8		
310107	1530	1300	M8		
310108	1755	1525	M8		
310109	1955	1725	M8		

Bremssseile Humbaur/WAP mit Trichter 25/28 mm außen

Einachser

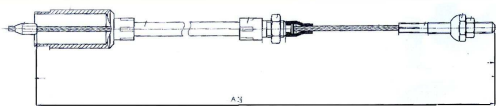

Bestell-Nr.	Ges.Länge B mm	Hülllänge A	Anschluss a	Hüllende
300203	1090	900	M8	M12x1,5

Tandem



Bestell-Nr.	Ges.Länge B mm	Hülllänge A	Anschluss a	Hüllende
300203	1090	900	M8	M12x1,5
300212	1390	1200	M8	M12x1,5

Bestell-Nr.	Bezeichnung
300034	Einhängeöse

Bowdenzüge AL-KO

Bowdenzüge mit Gewinde / Öse

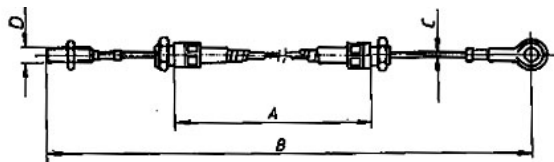

Bestell-Nr.	Hüllenslänge	Seillänge	Gewinde HL	Gewinde D
2172930001	400	610	M 14x1,5	M10
217745	490	700	M 16x1,5	M12
564553	545	755	M 16x1,5	M12
217743	550	760	M 14x1,5	M10
217782	550	800	M 16x1,5	M12
217744	700	910	M 14x1,5	M10
217746	700	910	M 16x1,5	M12
562240	700	935	M 16x1,5	M12
561410	750	980	M 14x1,5	M10
563647	750	980	M 16x1,5	M12
381594	870	1100	M 16x1,5	M12
562241	870	1105	M 16x1,5	M12
562567	870	1110	M 14x1,5	M10
1213047	900	1100	M 16x1,5	M12

Bowdenzüge mit Gewinde / Gewinde

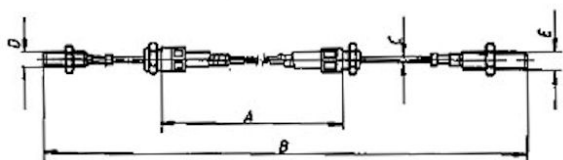

Bestell-Nr.	Hüllenslänge	Seillänge	Gewinde HL	Gewinde D/E
224679	360	645	M 16x1,5	M10 re/M10 li
2075750001	400	690	M 14x1,5	M10 re/M10 li
217742	460	710	M 16x1,5	M12 re/M12 li
217740	490	750	M 16x1,5	M12 re/M12 li
366185	490	760	M 16x1,5	M12 re/M12 li
217738	550	840	M 14x1,5	M10 re/M10 li
353473	550	800	M 16x1,5	M12 re/M12 li
350502	550	850	M 16x1,5	M12 re/M12 re
224188	550	840	M 16x1,5	M12 re/M12 li
15671029	670	1080	M 14x1,5	M10 re/M10 li
217739	700	990	M 14x1,5	M10 re/M10 li
217741	700	960	M 16x1,5	M12 re/M12 li
350503	700	1000	M 16x1,5	M12 re/M12 re
15671038	750	1080	M 12x1,5	M10 re/M10 li
353474	770	950	M 16x1,5	M12 re/M12 li
357143	1000	1280	M 16x1,5	M12 re/M12 li
1292864	1055	1360	M 16x1,5	M10 re/M12 li
224868	2300	2700	M 14x1,5	M10 re/M10 re

Bowdenzug BPW

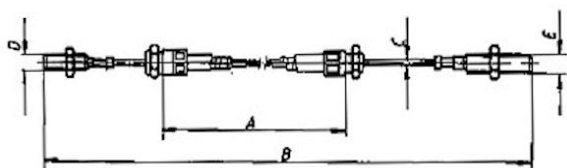

Bestell-Nr.	Hüllenlänge	Seillänge	Gewinde HL	Gewinde D/E
800750	740	1000	M14x1,5	M10 re/re
800265	717	1017	M14x1,5	M10 re/re
800320	880	1200	M14x1,5	M10 re/re
800323	1160	1400	M14x1,5	M10 re/re
800316	1130	1420	M14x1,5	M10 re/re
800319	1177	1477	M14x1,5	M10 re/re
800697	1180	1480	M14x1,5	M10 re/re
800321	1230	1530	M14x1,5	M10 re/re
810322	1275	1575	M14x1,5	M10 re/re
800266	1287	1637	M14x1,5	M10 re/re
810320	1300	1600	M14x1,5	M10 re/re
800322	1430	1730	M14x1,5	M10 re/re
800317	1630	1940	M14x1,5	M10 re/re
800953	1790	2110	M14x1,5	M10 re/re

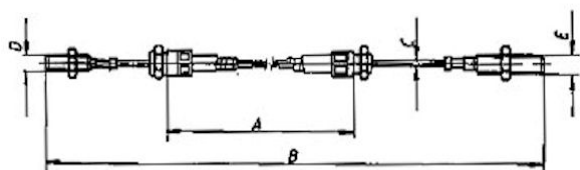

Bestell-Nr.	Hüllenlänge	Seillänge	Gewinde HL	Gewinde D/E
800938	680	980	M16x1,5	M12 re/re
800751	700	1000	M14x1,5	M12 re/re
800325	700	1100	M16x1,5	M12 re/re
800741	730	1160	M16x1,5	M12 re/re
800748	730	1390	M16x1,5	M12 re/re
801941	1100	1400	M16x1,5	M12 re/re
800941	1230	1530	M16x1,5	M12 re/re
800942	1230	1702	M16x1,5	M12 re/re
800939	1400	1725	M16x1,5	M12 re/re
800940	1655	1955	M16x1,5	M12 re/re

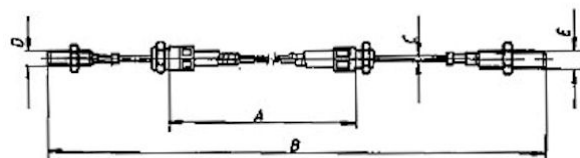

Bestell-Nr.	Hüllenlänge	Seillänge	Gewinde HL	Gewinde D/E
844271	710	1090	M12x1,5	M 8 re Gabelkopf
844291	910	1290	M12x1,5	M 8 re Gabelkopf
800921	1070	1510	M12x1,5	M10 re Gabelkopf
800982	1070	1635	M12x1,5	M8 re Gabelkopf
800922	1090	1530	M12x1,5	M10 re Gabelkopf
800734	1095	1660	M12x1,5	M10 re Gabelkopf
800272	1380	1720	M12x1,5	M10 re Gabelkopf

Bowdenzüge Hahn

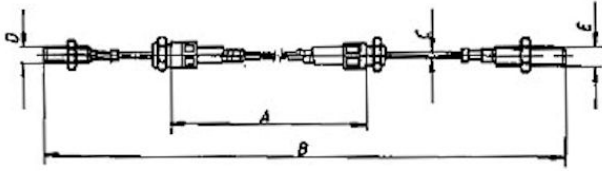

Bestell-Nr.	Hüllenlänge	Seil-länge	HL-Ende	Gewinde D/E
035090	600	915	14 mm gesteckt	M8 li/M12 re
095100	650	965	14 mm gesteckt	M8 li/M12 re
154570	700	1015	14 mm gesteckt	M8 li/M12 re
202930	750	1065	14 mm gesteckt	M8 li/M12 re
156830	800	1115	14 mm gesteckt	M8 li/M12 re
127080	950	1265	14 mm gesteckt	M8 li/M12 re

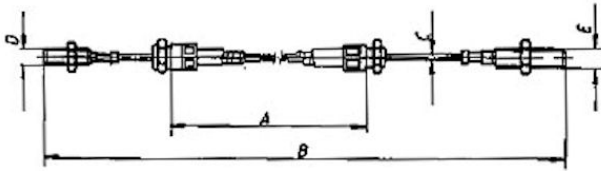

Bestell-Nr.	Hüllenlänge	Seil-länge	HL-Ende	Gewinde D/E
035130	750	1050	14 mm gesteckt	M10 re/M10 re
035140	825	1125	14 mm gesteckt	M10 re/M10 re
035150	900	1200	14 mm gesteckt	M10 re/M10 re

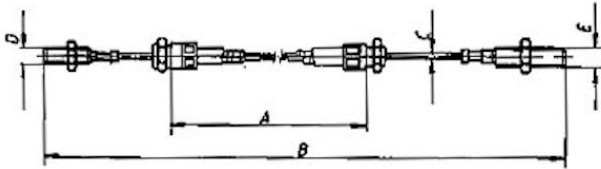

Bestell-Nr.	Hüllenlänge	Seil-länge	HL-Ende	Gewinde D/E
134610	350	705	14 mm gesteckt	M12 li/M12 re
131590	400	755	14 mm gesteckt	M12 li/M12 re
134620	450	805	14 mm gesteckt	M12 li/M12 re
131600	500	855	14 mm gesteckt	M12 li/M12 re
135330	550	905	14 mm gesteckt	M12 li/M12 re
035160	600	955	14 mm gesteckt	M12 li/M12 re
149240	650	1005	14 mm gesteckt	M12 li/M12 re
035180	700	1055	14 mm gesteckt	M12 li/M12 re
035190	750	1105	14 mm gesteckt	M12 li/M12 re
103960	800	1155	14 mm gesteckt	M12 li/M12 re
104530	850	1205	14 mm gesteckt	M12 li/M12 re
035200	900	1255	14 mm gesteckt	M12 li/M12 re
104540	1000	1355	14 mm gesteckt	M12 li/M12 re
160800	1050	1405	14 mm gesteckt	M12 li/M12 re
133210	1100	1455	14 mm gesteckt	M12 li/M12 re
248740	1200	1555	14 mm gesteckt	M12 li/M12 re
132280	1250	1605	14 mm gesteckt	M12 li/M12 re



Bowdenzüge Knott

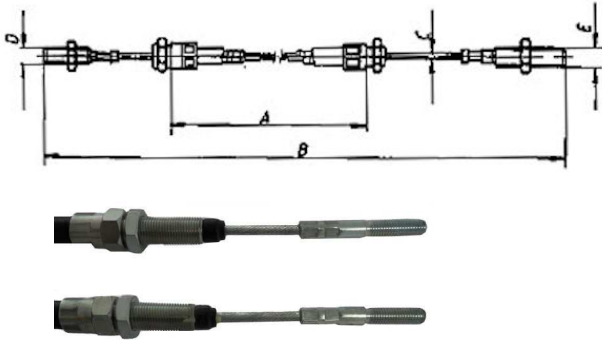

Bestell-Nr.	Hüllenslänge	Seillänge	HL-Ende	Gewinde D/E
600425	300	670	M16x1,5	M10 re/M10 re
600411	900	1270	M16x1,5	M10 re/M10 re
600421	1000	1370	M16x1,5	M10 re/M10 re
600422	1100	1470	M16x1,5	M10 re/M10 re
600410	1200	1570	M16x1,5	M10 re/M10 re
600437	1300	1670	M16x1,5	M10 re/M10 re
600423	1400	1770	M16x1,5	M10 re/M10 re
600424	1500	1870	M16x1,5	M10 re/M10 re
600413	1600	1970	M16x1,5	M10 re/M10 re
600412	850	1200	M16x1,5	M10re/M12re
600430	800	1250	M16x1,5	M10 re/M12re
600404	900	1350	M16x1,5	M12 re/M12 re
600414	1000	1370	M16x1,5	M12 re/M12 re
600428	1000	1500	M16x1,5	M12 re/M12 re
600415	1100	1470	M16x1,5	M12 re/M12 re
600401	1100	1550	M16x1,5	M12 re/M12 re
600427	1185	1650	M16x1,5	M12 re/M12 re
600416	1200	1570	M16x1,5	M12 re/M12 re
600409	1200	1700	M16x1,5	M12 re/M12 re
600436	1300	1670	M16x1,5	M12 re/M12 re
600417	1400	1770	M16x1,5	M12 re/M12 re
600429	1460	2000	M16x1,5	M12 re/M12 re
600418	1500	1870	M16x1,5	M12 re/M12 re
600408	1600	1970	M16x1,5	M12re/M12re
600419	1700	2070	M16x1,5	M12 re/M12 re
600433	2200	2550	M16x1,5	M12 re/M12 re
600420	2600	2970	M16x1,5	M12 re/M12 re
600402	1460	2000	M16x1,5	M12r re/M12re m.Gabelkopf

Bowdenzüge Peitz

Peitz PAV gekröpft

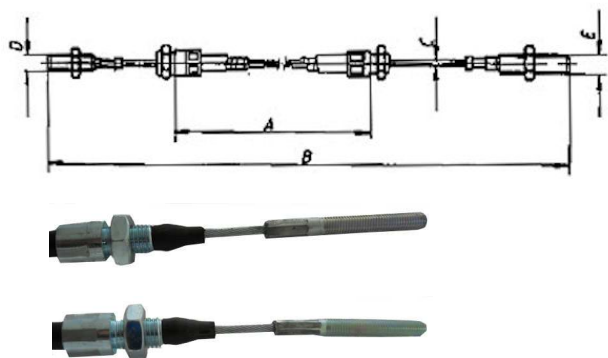

Bestell-Nr.	Hüllenlänge	Seillänge	Gewinde HL	Gewinde D/E
400360	360	630	M12 x 1,5	M8 li/M8 re
400429	430	700	M12x1,5	M8 li/M8 re
400430	430	730	M12x1,5	M8 li/M8 re
400431	460	730	M12x1,5	M8 li/M8 re
400432	800	1070	M12x1,5	M8 li/M8 re
400433	1000	1275	M12x1,5	M8 li/M8 re
400434	1200	1475	M12x1,5	M8 li/M8 re

Peitz PAV AEV höhenverstellbar

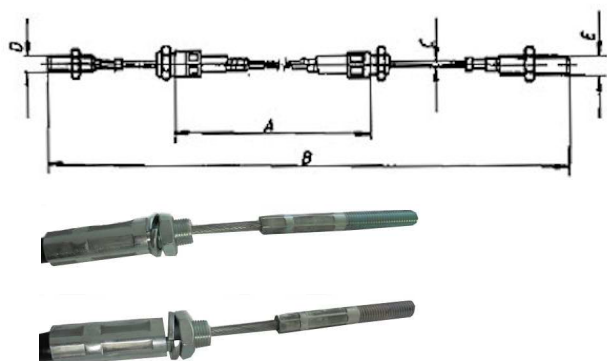

Bestell-Nr.	Hüllenlänge	Seillänge	Gewinde HL	Gewinde D/E
100940	1100	1450	M16x1,5	M 12 re/li
262980	1200	1550	M16x1,5	M 12 re/li
100941	1250	1600	M16x1,5	M 12 re/li
250610	1390	1740	M16x1,5	M 12 re/li
100942	1500	1830	M16x1,5	M 12 re/li

Peitz PAH höhenverstellbar

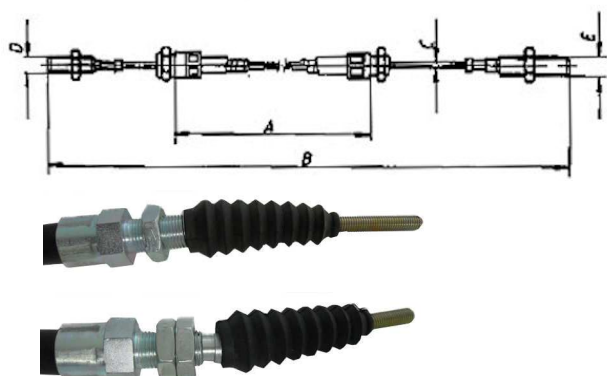

Bestell-Nr.	Hüllenlänge	Seillänge	Gewinde HL	Gewinde D/E
400440	800	1075	M16x1,5	M 8 re/li
400441	1000	1275	M16x1,5	M 8 re/li
400442	1000	1300	M16x1,5	M 8 re/li
400445	1050	1480	M16x1,5	M 8 re/li
400443	1150	1425	M16x1,5	M 8 re/li
400444	1200	1475	M16x1,5	M 8 re/li
400446	1230	1540	M16x1,5	M 8 re/li
400447	1400	1675	M16x1,5	M 8 re/li

Fettkappen

AL-KO



1235356



BPW



IFOR-Williams



Hahn



Bestell-Nr.	Durchmesser außen	Höhe
2381250003	40	25
2083990002	48	25
581197	55,5	29
1313924 waterproof	55,5 (blaue Kappe)	29
1651768 AAA	55,5	29
2687810004	56	27
2185680007	60	25
582505	66	29
1337300 waterproof	66 (blaue Kappe)	29
368527	70	33
2589290011	85	35
1235356	63,6 (schwarze Kappe)	22
1235357 waterproof	63,6 (schwarze Kappe)	22

Bestell-Nr.	Durchmesser außen	Höhe
800042	42	26
800078	48	23
800254 (N.m.l.)	50x1,5	n.m.l.
800151	53	33
800856(N.m.l.)	56x2 Gewinde	33
410527	64,5	34
840058	72	35
410540	80,5	32,5

Bestell-Nr.	Durchmesser außen	Höhe
710554 Kunststoff	76	30

Bestell-Nr.	Durchmesser außen	Höhe
024160	52	26
024170	59	30
024190	62	32
024210	M74x1 Gewinde	n.m.l.

Fettkappen

Knott



Bestell-Nr.	Durchmesser außen	Höhe
600147	47,1	23
600048	48	21
600049	52	29
691233	52	29
Auto. Adjust		
600267	52	29
waterproof	(blaue Kappe)	
600115	55	24
610280	64	27
691232	64	27
Auto. Adjust.		
600274	64	27
waterproof	(blaue Kappe)	
600050	65	27
630050	72	45
620402	80	34
630080	80,2	50

Nieper



Bestell-Nr.	Durchmesser außen	Höhe
780043	35	22
780051	47	26
780050	52	25
780056	64	27
780053	M48x1,5	26
780052	M54x1	n.m.l.

Peitz



Bestell-Nr.	Durchmesser außen	Höhe
409210	50	30
410527	64,5	34
450010	72	32
450011	80	52
450017	90	58
450021	120	35

Schlegl



Bestell-Nr.	Durchmesser außen	Höhe
752011	47	25
752031	52	25
752039	64	25

WAP



Bestell-Nr.	Durchmesser außen	Höhe
300002	48,4	25
300020	64,8	32

Radlager

Rillenkugellager



Lagerbezeichnung	Bestell-Nr. offen	Bestell-Nr. geschlossen	Maße innen/außen	Höhe/Schale
6003	005448		17/35	10
6004	005447	005447G	20/42	12
6005	005449	005449G	25/47	12
6006	005440	005440G	30/55	13
6203	005450	005450G	17/40	12
6204	005460	005460G	20/47	14
6205	005470	005470G	25/52	15
6206	005480	005480G	30/62	16
6303	005489	005489G	17/47	14
6304	005490	005490G	20/52	15
6305		005500G	25/62	17

Kegelrollenlager



Lagerbezeichnung	Bestell-Nr.	Maße innen/außen	Höhe/Schale
25520	005506	44,5/83	19
30203	005510	17/40	11
30204	005520	20/47	12
30205	005530	25/52	13
30206	005540	30/62	14
30207	005550	35/72	16
30208	005560	40/80	16
30209	005570	45/85	16
30210	005580	50/90	17
30211	005581	55/100	18
30304	005590	20/52	13
30305	005600	25/62	15
32004	005507	20/42	16
32005	005508	25/47	11,5
32006	005660	30/55	13
32007	005509	35/62	14
32008	800432	40/68	14,5
32011	005512	55/90	23
320/28	800433	28/52	12
32205	005620	25/52	15
32206	005630	30/62	17
32207	005640	35/72	19
32211	003610	55/100	21
33205	005700	25/52	18

Radlager

Kegelrollenlager



Lagerbezeichnung	Bestell-Nr.	Maße innen/außen	Höhe/Schale
LM 11749/10	704295	17,5/40	10,7
LM 11949/10	700764	19/45,3	12
LM 45449/10	704296	29/50,3	10,6
LM 44649/10	404058	27/50,3	10,6
LM 48548/10	670004	34,9/65,1	18,3
LM 48548/10 mit Dichtring integriert	670007	34,9/65,1	18,3
LM 501349/10	702325	41/73,4	14,7
LM 503349/10	700948	46/75	14
LM 67048/10	700771	31,6/59,2	11,9
639174 CBK171	005665	26/52	13/16
639177 CBK173	005666	20/43	13,4
639169	005667	18/47	14
15245/15123	702328	62,1/31,8	20,2
25520/25580	702326	44,5/82,9	19



Bestell-Nr.	Radlagersätze für AL-KO	Ausführung
258312	1x11949/10, 1x67048/10, 1x Wedi 42/62/7	200x50 m. Bremse
299056	1x11749/10, 1x45449/10, 1xWedi 40/52/7	160x35 Laufachse
258310	1x30203, 1x30205, 1x Wedi 30/52/7	SB/SR 160
258311	1x30204, 1x30206, 1x Wedi 42/62/7	SR201-203
258313	1x32005, 1x32007, 1x Wedi 42/62/7	mit Bremse 2350 bis 1600 kg 2361 bis 1600 kg
299055	1x501349, 1x32006, 1x Wedi 55/75/7	mit Bremse 2360 bis 1750 kg 2361 bis 1750 kg

Radlager



Bestell-Nr.	Radlagersatz für BPW Bremse 200x50 Einzellagerung
842051	1x30204, 1x30206, 1xDichtscheibe 30/62/9,5 3-tlg



Bestell-Nr.	Radlagersatz für Knott Bremse 200x30/200x50
622010	1x30205, 1x30206, 1xDichtscheibe 30/62/10



Bestell-Nr.	Radlagersatz für Peitz Achsen EBD/EBG
423041	1x30204, 1x30206, 1xDichtscheibe 30/62/11



Bestell-Nr.	Radlagersatz für Schlegl Achsen SGB
751502	1x32304, 1x32206, 1xWedi 48/62/8

Bestell-Nr.	Radlagersatz für Westfalia un-/gebremst
622009	1x30204, 1x30206, 1xDichtscheibe 30/62/10

Bestell-Nr.	Wälzlagerfett
850580	ECO-LI 45 gr. pro Radseite Speziell geeignet auch für Bootstrailer

Kompaktlager



Bestell-Nr.	Bezeichnung	Maße innen/außen	Höhe/Schale
500584	Kompaktlager	30/60	37
410528	Kompaktlager	34/64	37
410529	Kompaktlager wasserdicht	34/64	37
710243	Kompaktlager	35/75	60
500585	Kompaktlager	39/72	37
510585	Kompaktlager wasserdicht	39/72	37
710242	Kompaktlager	42/76	39
410542	Kompaktlager	42/78	45
500586	Kompaktlager	42/80	42
752305	Kompaktlager	55/90	60

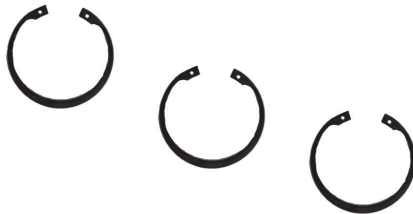

Bestell-Nr.	Bezeichnung	Maße innen/außen
501584	Sicherungsring	30 x 2
610254	Sicherungsring	64 x 2
410525	Sicherungsring	64 x 3
704437	Sicherungsring	64 x 4
610261	Sicherungsring	72 x 2
410531	Sicherungsring	72 x 3
501586	Sicherungsring	80 x 2
752306	Sicherungsring	90 x 2

Kompaktlager/-Set



Bestell-Nr.	AL-KO	Radbremse	Maße innen/außen/Höhe
1224800	ET-Set Compactlager	1637	30/60/37
1224801	ET-Set Compactlager	2051	34/64/37
1224802	ET-Set Compactlager wasserdicht	2051	34/64/37
1224803	ET-Set Compactlager	2051	39/72/37
1224804	ET-Set Compactlager wasserdicht	2051	39/72/37
1224805	ET-Set Compactlager	2361	42/80/42
1224806	ET-Set Compactlager wasserdicht	2361	42/78/45



Bestell-Nr.	Knott/Nieper/Schlegl	Radbremse	Maße innen/außen/Höhe
622012	ET-Set Kompaktlager	Diverse	34/64/37
622013	ET-Set Kompaktlager	Diverse	39/72/37



Bestell-Nr.	BPW	Radbremse	Maße innen/außen/Höhe
622014	ET-Set Kompaktlager	-7	34/64/37
622015	ET-Set Kompaktlager	-7	39/72/37



Bestell-Nr.	AL-KO	Laufachse	Maße innen/außen/Höhe
1730742	ET-Set Compactlager	Optima	30/60/37

Werkzeuge



Bestell-Nr.	Handtreiber für AL-KO	Radbremse
603751	Handtreiber für Radbremse	1637 2051
603752	Handtreiber für Radbremse	2361



Bestell-Nr.	Werkzeuge für das Wechseln der Kompaktlager
1365642	Werkzeug für Lager Ø 30
1365643	Werkzeug für Lager Ø 34
1365644	Werkzeug für Lager Ø 39
1365645	Werkzeug für Lager Ø 42



Bestell-Nr.	Werkzeugeinsatz 1/2 Zoll f. Drehmomentschlüssel
804055	Werkzeugeinsatz 12-Kant für Drehmomentschlüssel Passend für Laufachse Optima Flanschnutter 1650313

Flanschmutter / Kronenmutter



Bestell-Nr.	Flanschmutter	
581200	AL-KO	M24x1,5
582506	AL-KO	M27x2

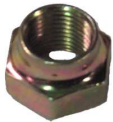

Bestell-Nr.	Sicherungsmutter	
1312008	AL-KO	M16x1,5



Bestell-Nr.	Flanschmutter 12 Kant	
1650313	AL-KO	M24x1,5



Bestell-Nr.	Flanschmutter	
610253	Knott/Nieper/ Schlegl/WAP M24x1,5	



Bestell-Nr.	Flanschmutter	
610276	Knott für Sonderachse VGB15MV M30x1,5	

Bund geschlitzt



Bestell-Nr.	Flanschmutter	
410526	BPW	M24x1,5
410536	BPW	M24x1,5
840019	BPW	M27x1,5



Bestell-Nr.	Flanschmutter	
710253	IFOR - Williams	M29x1,5



Bestell-Nr.	Kronenmutter	
700754	M16x1,5	
700117	M18x1,5	
600044	M20x1,5	
700118	M22x1,5	
600045	M24x1,5	
630303	M30x1,5	
701277	M33x1,5	
600099	M30x2	



Lagerdichtungen

AL-KO



700272

BPW

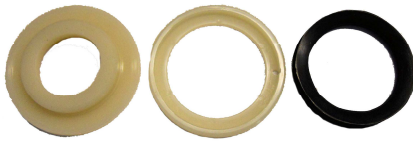

800062

Hahn



136420

Bestell-Nr.	Bezeichnung	Innendurchm.	Außendurchm.	Höhe
700777	Simmerring	30	52	7
70077710	Simmerring	30	52	10
70077720	Simmerring	32	52	7
701272	Simmerring	42	62	10
701511	Simmerring	40	52	7
1312430	Dichtung zweilippig	40	52	7
700272	Simmerring	42	62	7
700779	Simmerring	55	75	7
358893	Simmerring	64	100	13

Bestell-Nr.	Bezeichnung	Innendurchm.	Außendurchm.	Höhe
800426	Dichtring zu 800425	30	62	15
800425	Dichtring zu 800426	32	62	18
800062	Dichtring 3-tlg.	30	62,5	9
810062	Dichtring	30	63	9,1
800046	Dichtring	35	62	5
800047	Dichtring	35	62	7
800429	V-Ring	37	47	4
807072	Wellendichtring	38	55	7
807073	Dichtring	45	62	5
810430	Dichtring	39,8	67,8	8
800431	Ring	40	68	7,5
800427	Dichtring	50	88,5	
800428	Nilos-Abdicht.	50	88	6
800430	V-Ring	55	70	11

Bestell-Nr.	Bezeichnung	Innendurchm.	Außendurchm.	Höhe
136400	Nutring	25	52	6,5
154450	Nutring	25	52	5
700777	Simmerring	30	52	7
136420	Nutring	30	62	11
006640	Simmerring	34	52	7
197960	Nutring	35	62	12
207070	Nutring	35	72	13
243870	Nutring	45	85	7
243871	Nutring	50	90	8
248650	Nutring	55	100	8

Lagerdichtungen

Knott



600041

Bestell-Nr.	Bezeichnung	Innendurchm.	Außendurchm.	Höhe
600040	Anschlagscheibe	30	62	10
600041	Anschlagscheibe	30	62	13
600042	Anschlagscheibe	35	72	5
600046	Anschlagscheibe	35	72	7
600141	Dichtring	38	62	8
600224	Dichtring	43,5	56	7
600271	Dichtring	44	55	5
600279	Wellendichtring	45,6	56	7
4400340	Wellendichtring	44	64	9
4400530	Wellendichtring	44	70	9
600109	Anschlagscheibe	45	94	10
610255	Dichtscheibe	48	63	5
N.m.l.	Dichtscheibe	53	72	6
600223	Dichtring	53	72	8
600043	Anschlagscheibe	55	100	7

Nieper



780005



780008

Bestell-Nr.	Bezeichnung	Innendurchm.	Außendurchm.	Höhe
780028	Distanzring zu 780025	25	47	6
780025	LSTO-Ring zu 780028	25	47	4
780005	Distanzring zu 780008	25	52	4
780008	Nilos-Abdicht.	25	52	4
780026	Dichtring	30	45	10
780024	Simmerring	30	47	7
780015	Nutring	30	62	11
780009	Distanzring zu 780016	30	62	5
780016	Nilos-Abdicht. zu 780009	30	62	4
780017	LSTO-Ring	30	62	4
780021	Nilos-Abdicht.	35	72	4
780038	Dichtring	35	48	9
780040	LSTO-Ring zu 780014	35	72	4
780018	Simmerring	45	62	8
780039	Simmerring	48	72	7
780307	Distanzring zu 780306	50	88	10
780306	Nilos-Abdicht. zu 780307	50	88	6

Lagerdichtungen

Peitz



404063

Bestell-Nr.	Bezeichnung	Innendurchm.	Außendurchm.	Höhe
404060	Nutring	25	47	8
404061	Nutring	25	52	10
404062	Nutring	25	52	10
404054	Simmerring	35	52	7
404067	Nutring	30	55	12
404063	Nutring	30	62	11
404057	Nutring	35	62	11
404059	Simmerring	40	62	10

Schlegl



752049

Bestell-Nr.	Bezeichnung	Innendurchm.	Außendurchm.	Höhe
752049	Wellendichtring	45	65	5
752008	Wellendichtring	48	62	8
404063	Nutring	30	62	11

WAP



300035

Bestell-Nr.	Bezeichnung	Innendurchm.	Außendurchm.	Höhe
300001	Wellendichtring	35	62	10
300035	Wellendichtring	45	68	8

Radbolzen / Radmuttern

Radbolzen



Bestell-Nr.	Ges.-Länge	Länge Rändel +Gewinde	Länge Rändel	Gewinde Länge	Durchmesser Rändelung	Gewinde
411008	41	36	10	25	14,7	M12x1,5
016440	42	36	9	25	17	M12x1,5
411003	46	41	9	32	19,9	M12x1,5
411006	60,4	55	9	46	14,5	M12x1,5
016460	47,6	42,6	9	34	17	M14x1,5
411007	54,4	41,9	12	33	17	M14x1,5
610258	56,4	50	10	42,1	14,5	M14x1,5
450014	51,4	46	10	31	21	M18x1,5
450012	56	50,5	14	31,6	20	M18x1,5
450013	57	50	14	31	21	M18x1,5
016510	63,3	57	22	32	21	M18x1,5
016441	46	41	9	29	17	Zoll (11)

Radmuttern



Kugel



Kegel

Bestell-Nr.	Durchmesser Kugel/Kegel	Gesamt Höhe	Kugel/ Kegelbund	Gewinde Länge
010941	22	18	Kugel	Zoll
010940 SW17	23	18	Kugel	M12
010942	26	21	Kugel	M12
010950	26	21	Kugel	M14
450015	28	20	Kugel	M18
010530 SW19	—	14	Kegel	M12
010531	—	14,5	Kegel	Zoll

Radschrauben / Schutzkappen



Radschrauben

Bestell-Nr.	Durchmesser Kugel/Kegel	Gesamt Länge	Kugel/ Kegelbund	Gewinde Länge	Gewinde Durchmesser
010799	18	37	Kugel	22	M10x1,25
010800 SW 19	24	44	Kugel	25	M12x1,5
010801	28	44	Kugel	23	M12x1,5
010802	24	46	Kugel	25	M14x1,5
010803	30	50	Kugel	22	M18x1,5
010804 SW 19	60 Grad	41	Kegel	24	M12x1,5



Schutzkappen Sechskant



Bestell-Nr.	Gewinde	VPE
946630 SW 10	M6	100
946631 SW 13	M8	100
946632 SW 17	M10	100
946633 SW 19	M12	100
946634 SW 22	M14	100

Westfalia Auflaufeinrichtungen V-Deichsel

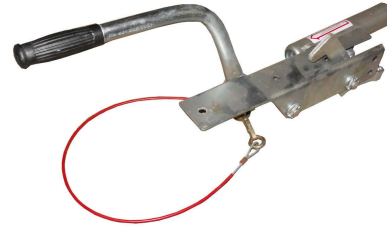

Bestell-Nr.	Typ	Flanschmaß	Gewichtsbereich
760100	WAE 1202	Oberteil	750-1200 kg
760111	WAE 1202	Unterteil	750-1200 kg



Bestell-Nr.	Typ	Flanschmaß	Gewichtsbereich
760210	WAE 2000 (ZARW 2,0-1)		1089-2000 kg

Westfalia - Schräglenker Comfort

Bis Baujahr 1982



Bestell-Nr.	Bezeichnung
761101	Schräglenker links Bis 800 kg Einachser & 1600 kg Tandem Achsstummel angeschweißt
761102	Schräglenker rechts Bis 800 kg Einachser & 1600 kg Tandem Achsstummel angeschweißt



Bestell-Nr.	Bezeichnung
761303	Schräglenker links Ab 1000 kg je Achse Achsstummel angeschweißt
761304	Schräglenker rechts Ab 1000 kg je Achse Achsstummel angeschweißt

Ab Baujahr 1983



Bestell-Nr.	Bezeichnung
761211	Schräglenker rechts + links Bis 750 kg gebremst & ungebremst Achsstummel angeschraubt



Bestell-Nr.	Bezeichnung
761451	Schräglenker rechts + links Ab 800 kg bis 2600 kg



Bestell-Nr.	Bezeichnung
761220	Schräglenker vorne rechts & hinten links Pferdeanhänger Vollpoly-Haube
761221	Schräglenker vorne links & hinten rechts Pferdeanhänger Vollpoly-Haube

Im Lieferumfang sind Ausgleichsbuchsen und Distanzrohre enthalten!!!

Westfalia - Drehschubfeder

Ab Baujahr 1983



Bestell-Nr.	Bezeichnung
761213	Schräglenker rechts + links 600 kg ohne Bremse / ohne Radnabe Drehschubfeder Typ 118113 & 118133



Bestell-Nr.	Bezeichnung
761214	Radnabe 100x4 passend für Schräglenker 761213 Drehschubfeder Typ 118113 & 118133 Inkl. Radlager, Kronenmutter, Scheibe, Fettkappe und Splint



Bestell-Nr.	Bezeichnung
761133	Drehschubfeder links Typ 118113 & 118133
761134	Drehschubfeder rechts Typ 118113 & 118133



Bestell-Nr.	Bezeichnung
761135	Montagesatz Drehschubfeder



Bestell-Nr.	Bezeichnung
761136	Aufnahme links für Drehschubfeder
761137	Aufnahme rechts für Drehschubfeder

Westfalia Achsstossdämpfer



Bestell-Nr.	Bezeichnung	Maß mm ausgefahren	Maß mm eingefahren
761070 (VPE2)	Westfalia	320	220



Bestell-Nr.	Bezeichnung
761032	Cellastofeder 400 kg Gewindestift M8 / Mutter M8



Bestell-Nr.	Bezeichnung
761031	Bundbuchse 400 kg



Bestell-Nr.	Bezeichnung
761033	Cellastofeder 600/800 kg Gewindestift M10 / Gewindestift M10



Bestell-Nr.	Bezeichnung	Gewichtsbereich
761034	Schraubenfeder Schwarz	nur 900 kg
761035	Schraubenfeder Blau	bis 1000 kg
761036	Schraubenfeder Gelb	1200 kg
761037	Schraubenfeder Grün	1400 kg



Bestell-Nr.	Bezeichnung
761038	Druckteller groß oben/unten
761039	Druckteller klein oben
2161035	Schraube 6kt M10 x 35
761040	Druckteller klein unten mit Skt. Mutter



Bestell-Nr.	Bezeichnung
761212	Buchsensatz für Längslenker Westfalia Bestehend aus: Je 2x Schraube, Distanzrohr, Ausgleichsbuchse

Westfalia Halter Radstossdämpfer



Bestell-Nr.	Bezeichnung
761065	Halter Radstossdämpfer Comfort ab 1995
761066	Halter Radstossdämpfer Comfort ab 1995



Bestell-Nr.	Bezeichnung
761067	Halter Radstossdämpfer Comfort 1983-1995
761068	Halter Radstossdämpfer Typ 118001

Westfalia Kotflügel

Westfalia Tandem



Bestell-Nr.	Breite B	Höhe H	Spannweite S
760524	234 mm	381 mm	1451 mm

Ausführung Westfalia



Bestell-Nr.	Breite B	Höhe H	Spannweite S
760513	215 mm	13 Zoll	680 mm
760514	240 mm	14 + 15 Zoll	741 mm

Westfalia Gasfedern Pferdeanhänger

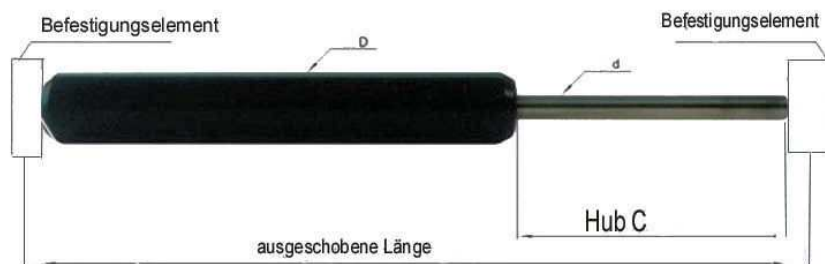

Westfalia

Federkraft	Hub mm	Federlänge mm von Mitte bis Mitte Auge Eingeschoben/Ausgeschoben		Augen- durch- messer	Zylinder	Kolbenstange	Bestell-Nr.
1100 N	300	420	720	10 mm + WG	28 mm	14 mm	764000
1900 N	300	420	720	10 mm + WG	28 mm	14 mm	764001
2100 N	300	415	715	10 mm + WG	28 mm	14 mm	764002
2100 N	300	400	710	10 mm	28 mm	14 mm	764003
1100 N	Lüftungsklappe oben			WG WG			764004
1300 N			XL	WG WG			764005

Lüftungsklappe oben

WG= Winkelgelenk

Einbauhinweise für Gasfedern:

- Einbau mit nach unten gerichteter Kolbenstange
- seitlich angreifende Kräfte sind unzulässig
- beim Einbau nicht verkanten
- Kolbenstange vor Verschmutzung, Beschädigung, Farbe und Schweißspritzern schützen
- Bearbeitung jeglicher Art sind zu unterlassen
- Nicht öffnen!! Hoher Druck bis 200 bar
- Nicht über 120°C erwärmen!
- Gasfedern nur im eingebauten Zustand betätigen

Westfalia Gasfedern für Haube/Deckel



Bestell-Nr.	Bezeichnung
764006	Gasfeder für Haube (Aufbau L= 253)
764007	Gasfeder mit Sicherung für Haube (Aufbau L= 253)
764008	Gasfeder für Haube (Aufbau L= 300)
764009	Gasfeder mit Sicherung für Haube (Aufbau L= 300)

Bestell-Nr.	Bezeichnung
764011	Gasfeder für Deckel

Bestell-Nr.	Bezeichnung
764012	Abdeckung links
764013	Abdeckung rechts

Spannriegelverschluss



Westfalia

Bestell-Nr.	Bezeichnung
762001	Spannriegelverschluss m. T-Stück
762002	Gegenhalter zu 762001

Westfalia Scharniere

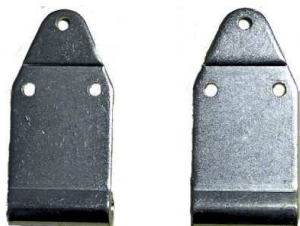

Bestell-Nr.	Bezeichnung
763459	Scharniere Heckklappe Westfalia-Comfort VPE=2 Stck.



Bestell-Nr.	Bezeichnung
763451	Scharnierlager Endtraverse Westfalia-Comfort VPE=2 Stck.



Bestell-Nr.	Bezeichnung
763452	Scharnier Heckklappe Westfalia-Comfort

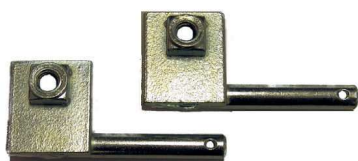

Bestell-Nr.	Bezeichnung
763453	Scharnierlager Endtraverse Westfalia-Comfort VPE=2 Stck.



Bestell-Nr.	Bezeichnung
763454	Scharnier Heckklappe Westfalia-Compact VPE=2 Stck.

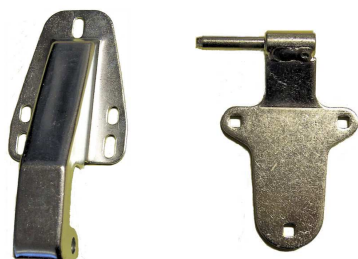

Bestell-Nr.	Bezeichnung
763456	Scharnier-Oberteil GFK-Deckel
763455	Scharnier-Unterteil GFK-Deckel

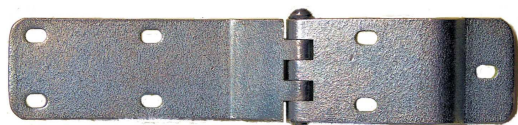

Bestell-Nr.	Bezeichnung
763457	Scharnier für GFK-Haube



Bestell-Nr.	Bezeichnung
763458	Türscharnier Pferdeanhänger Jupiter für Seitentür und Sattelkammer (auch für Böckmann)

Westfalia Beleuchtung

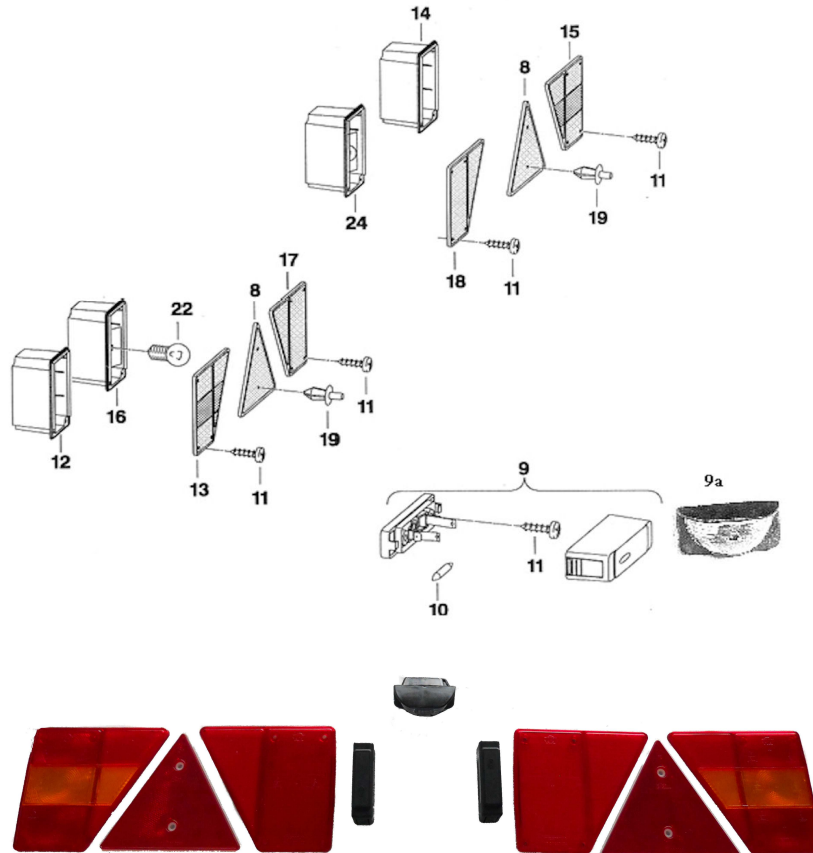

Position	Bezeichnung	Bestellnummer
08	Rückstrahler	925541
09	Kennzeichenleuchte (Neu)	935321
09a	Kennzeichenleuchte (Alt)	920532
10	Sofitte 12V/5W	960911
11	Schraube	765015
12	Leuchte links incl. Pos.13	765000
13	Lichtscheibe links	765001
14	Leuchte rechts incl. Pos. 15.	765005
15	Lichtscheibe rechts	765006
16	Nebelschlussleuchte links incl. Pos. 17	765002
17	Lichtscheibe links Nebelschluss	765003
17	Attrappe für Lichtscheibe ohne NBS	765016
18	Attrappe f. Leuchte	765008
18	Lichtscheibe RFS	765009
19	Spreizniet f. Rückstrahler	925411
22	Glühlampe 12V/21W	960905
24	Rückfahrleuchte	765007

Westfalia Endtraversen

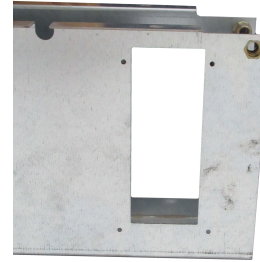

Bestell-Nr.	Endtraverse Westfalia
763414	Endtraverse mit Rahmenschutz für Aufbau Breite 1140 mm
763426	Endtraverse mit Rahmenschutz für Aufbau Breite 1260 mm
763439	Endtraverse mit Rahmenschutz für Aufbau Breite 1390 mm
763478	Endtraverse mit Rahmenschutz für Aufbau Breite 1780 mm

DDR - Ersatzteile

Auflaufeinrichtung



Bestell-Nr.	Für Anhänger aus der DDR-Produktion
740080	KK 92 Ausf. A Ø 70 mm horiz. M12
740082	KK 92 Ausf. B Ø 60 mm horiz. M12
740081	KK 92 Ausf. F □ 60 mm horiz. M12



Bestell-Nr.	Bezeichnung
740089	Adapterplatte zum Höhenausgleich DDR



Bestell-Nr.	Bezeichnung
740083	E10-201-120/35 Auflaufdämpfer HP 500
740084	E10-201-210/55 Auflaufdämpfer HP 800



Bestell-Nr.	Bezeichnung
740088	Faltenbalg DDR



Beleuchtung verwendbar

Bestell-Nr.	194 x 104 x 59 mm	Hersteller
999128	Leuchte BBS 8100	Radex
999129	Leuchte BBSK 8101	Radex
999135	Lichtscheibe 8100 / 8101	Radex



Bestell-Nr.	115 x 58 mm	Hersteller
930539	Leuchte BBS ohne Kennzeichen	Hella
935391	Leuchte BBS mit Kennzeichen	Hella
930540	Lichtscheibe	Hella



Bestell-Nr.	140 x 70 mm	Hersteller
930541	Leuchte BBS ohne Kennzeichen	

DDR - Ersatzteile



Bremsbacken

Bestell-Nr.	Anhängertyp	Größe	Hersteller
740033 (ohne Federn)	HP500/600 (Spreizhebel)	200x30	DDR
740104	Federnsatz	pro Achse	DDR



Bestell-Nr.	Anhängertyp	Größe	Hersteller
740035 (ohne Federn)	HP800 (hydr.)	230x50	DDR
740104	Federnsatz	pro Achse	DDR



Buchsen

Bestell-Nr.	Bezeichnung	Typ	Maß
740040	Gummifeder	HP300 / 350 / 400	63 x 63 mm
740041	Gummifeder	HP300 / 350 / 400	63 x 100 mm
740042	Gummifeder	HP300	50 x 50 mm



Silentbuchse

Bestell-Nr.	Bezeichnung	Durchmesser	Maß
740085	Silentbuchse S1	32,2 mm	L=54 mm
740086	Silentbuchse S2	27 mm	L=54 mm



Gummianschlag

Bestell-Nr.	Bezeichnung
740087	Gummianschlag für Schwinge



Bestell-Nr.	Bezeichnung	Augen innen Ø
740090	Radstossdämpfer Multicar	14